

# ELEGANCIA 6636

66" x 36" x 21"

With shapes and lines that take us back to the Victorian era, this collection transcends time, fitting right in with today's styles.

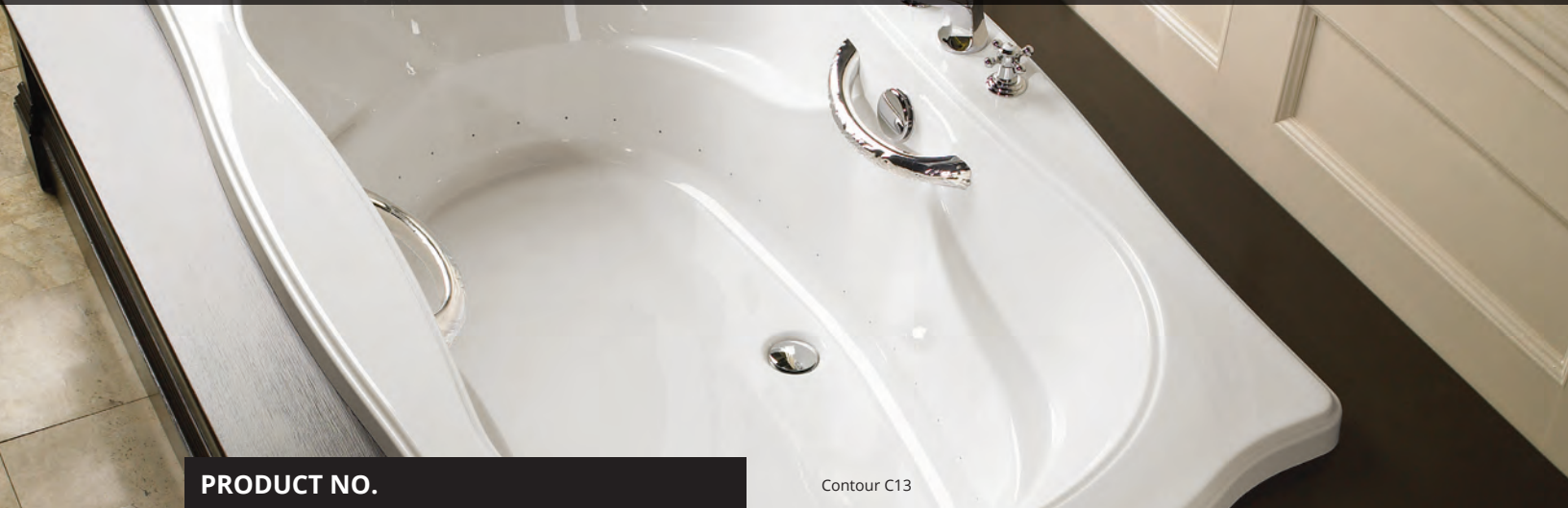



Contour C13

## PRODUCT NO.

MODEL	TMU	TUB
C10	BELLRDA0T-XX	BELLRDA0N-XX
C11	BELLODB0T-XX	BELLODB0N-XX
C12	BELLRBC0T-XX	BELLRBC0N-XX
C13	BELLODD0T-XX	BELLODD0N-XX
C14	BELLODE0T-XX	BELLODE0N-XX

THERMOMASSEUR (TMU) Hydro-thermo massage • Air jet system	\$
Jets	36
1 heated backrest	Included
MiaPlus® Control	Included
BU-Touch Control Application <b>BUTOUCH NEW</b>	\$
Geysair®	Included
AromaCloud® <b>BAROMAC</b>	\$
Illuzio Chromatherapy <b>BCHRO6</b>	\$
2 <sup>nd</sup> heated backrest (WTS-1 zone) <b>BSHB</b>	\$

TUB Soaker	\$
AromaCloud® <b>BAROMAC</b>	\$
Illuzio Chromatherapy <b>BCHRO6</b>	\$
WarmTouchShell® <b>BWTS</b>	\$
DOT control	Included with therapy
2 <sup>nd</sup> WarmTouchShell® <b>BWTS2</b>	\$

FEATURES	
Installation type	Drop-in & Alcove (3 walls) for C12 only
No. of bathers	2
US gallons	46
Imp. gallons	38
STANDARD COLOR	
 White <b>01</b>  Biscuit <b>02</b>	Included

## OPTIONS (UPCHARGE APPLICABLE)

<b>SKIRT</b> (with C12 only)	<b>MULTIFIT</b> BSMUL-XX	<b>SJ-1</b> BSJ1-XX
White <b>01</b> , Biscuit <b>02</b>	\$	\$
<b>GRAB BARS</b>	<b>G11 METALLIC</b> BGBG11-XX	<b>CLEAR ACRYLIC*</b> BGBG10-XX
Chrome <b>07</b>	\$	\$
Brushed Nickel <b>09</b>	\$	\$
Polished Nickel <b>10</b>	\$	N/A
<b>WASTE &amp; OVERFLOW</b>	<b>D13</b> BOVERD13-XX	<b>D14**</b> BOVERD14-XX
Chrome <b>07</b>	\$	\$
White <b>01</b> , Biscuit <b>02</b>	N/A	\$
Brushed Nickel <b>09</b> , Polished Nickel <b>10</b>	\$	\$
Unplated <b>00</b> , Oil-rubbed Bronze <b>11</b>	\$	N/A
<b>TILE FLANGE</b> (for C12 contour only) (specify front or back)		
Ordered with bath (not installed) <b>BTILEN</b>		\$
Factory-installed. Front <b>BTILEF</b> , Back <b>BTILEB</b> , Special installation <b>BTILEO</b>		\$

 **Don't forget to select a contour among the 5 available to choose from.**  
 \* Specify insert finish. With Chrome or Brushed Nickel inserts.  
 \*\* Piping is not included for this model (waste & overflow D14).

<b>TOTAL PRICE</b>	\$
--------------------	----



Contour C13

## ELEGANCIA 6636

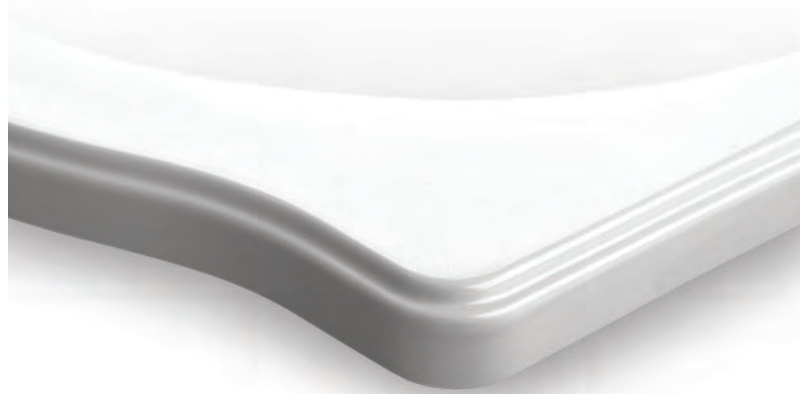

Contour C13

### INSTALLATION

- A** When tile flange is added, the AromaCloud® will automatically be installed on the opposite side of the flange (C12 only).

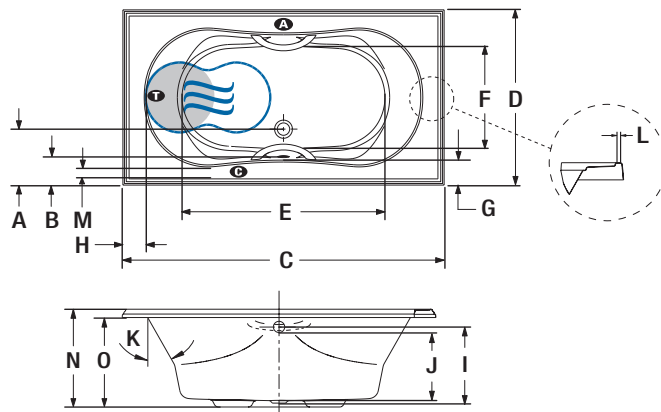

LETTER	DESCRIPTION	MEASURE
A	Outside edge to center drain	11 1/2"
B	Outside edge to overflow	5 1/2"
C	Total length	66"
D	Total width	36"
E	Bathing well length	42"
F	Bathing well width	21 3/8"
G	Deck width (widest point)	5 1/4"
H	Deck width at backrest end	4 3/4"
I	Height from drain to center of overflow	16"
J	Maximum water level	14 3/8"
K	Slope of backrests	30°
L	Flat contour width (narrowest point) C12 only	0 3/8"

- A** AromaCloud® position
- C** Control position when factory-installed (Mia® or DOT)
- T** Turbine position (TMU)
- Indicates heated backrest (TMU)
- ☞ Indicates WarmTouchShell® position (TUB)

### CHOOSE YOUR CONTOUR

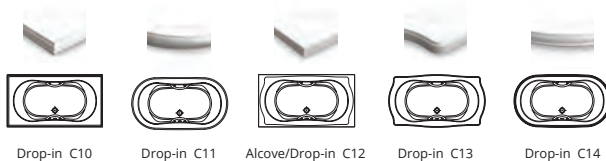

Drop-in C10

Drop-in C11

Alcove/Drop-in C12

Drop-in C13

Drop-in C14

LETTER	M	N	O
<b>DESCRIPTION</b>	Deck width (narrowest point)	Height from bottom of bath to top deck	Height from bottom of bath to bottom of lip
<b>C10</b>	3 1/4"	20 3/4"	18 1/4"
<b>C11</b>	3 1/2"	20 5/8"	17 5/8"
<b>C12</b>	3 5/8"	21"	19"
<b>C13</b>	3 5/8"	20 5/8"	18 5/8"
<b>C14</b>	3 1/4"	20 3/4"	18 1/4"

### TECHNICAL SPECIFICATIONS

<b>Hot water supply required</b>	Should be 70% of water capacity of TUB or greater.
<b>Turbine</b>	Access to the pump must be at least 18" x 22". <b>Standard connection is 20 A, 120 V, 60 Hz</b> , dedicated line with a Ground-Fault Circuit Interrupter (GFCI). <b>For any additional option, a second line is needed 15 A, 120 V, 60 Hz</b> , dedicated line with a GFCI. Air vent necessary: 2" x 4" minimum.
<b>Others</b>	- <b>The GEYSAIR must always be accessible and connected to the hot water supply (provide access).</b> - Optional tile flange for C12 contour (specify front or back).

Our products must be installed by certified professionals only and according to our Owner's Manual as well as federal, provincial/state and local building codes and regulations ([www.bainultra.com/documentation/documentation](http://www.bainultra.com/documentation/documentation)).

<b>Cutting template</b>	# 90000044 (C11, C13 & C14)
<b>Approx. shipping weight</b>	135 lbs
<b>Turbine power</b>	550 W
<b>Air heater</b>	600 W
<b>WARRANTY</b>	
Controls-LED-Geysair*	5 years
Bath & turbine*	20 years

\* Some restrictions apply | [www.bainultra.com/warranty](http://www.bainultra.com/warranty)



The specifications shown indicate the outer edge dimension and the inside bathing capacity dimension measured at air jets' height. The manufacturer accepts a 1/4" [0.64 cm] variance. There are variations on each product and specifications are subject to change as we improve upon our product as required. The dimensions needed for site preparation and structure building will differ. BainUltra® assumes no responsibility for preparatory work done prior to the product being on site.